

Portofino

I due soffici cuscini realizzati in ovatta con un leggero punto di trapunta centrale che enfatizza la morbidezza e il loro rivestimento continuo con la testata dona al Portofino una rigorosa e piacevole pulizia di linee. Realizzabile in tinta unita o in quattro abbinamenti bicolore. In questo caso l'interno della testata è realizzato in colore a contrasto rispetto al rivestimento del letto. / The two soft polyester filling cushions with a light central stitching emphasizes the effect of softness while the seamless cover, between cushion and headboard, gives a rigorous and pleasant cleanliness of the lines. Available in a plain color or in four bicolor options. In this case the inside of headboard's edge is realized in a contrasting color to the one of the entire bed.

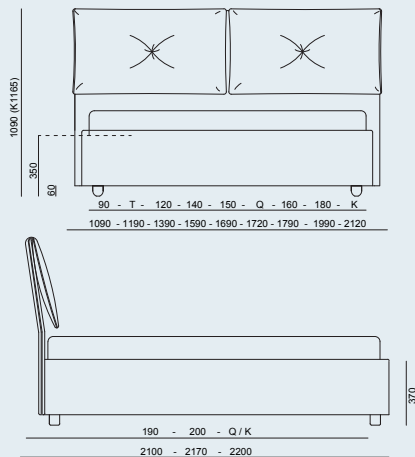

*Disegno con piede **standard**, cambiando il piede variano anche l'altezza complessiva del letto e il piano d'appoggio del materasso. / The production drawings are referred to the bed with standard feet. Any foot change will also imply a change of the height and of the mattress base.



*Letto **compatibile con tutti i piedi Noctis**, vedi pp. 10-11 del listino.
*Bed **compatible with all Noctis feet**, see pp. 10-11 of the list.

☞ Disponibile in tutti tessuti del nostro campionario.

☞ Available in all the fabrics of our catalogue

Non sfoderabile
Not removable cover



Piedi proposti*
Proposed feet

Legno P2
P2 Wood

H
H

Natural
Natural

Bianco
White

Wengè
Wengè

Pantone
Pantone

60
110
150
250



€ 30
€ 35
€ 40
€ 50



€ 30
€ 35
€ 40
€ 50

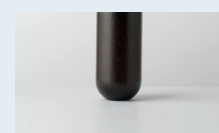

€ 30
€ 35
€ 40
€ 50

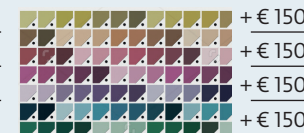

+ € 150
+ € 150
+ € 150
+ € 150

Piedi proposti*
Proposed feet

Polipropilene Campana
Polypropylene Bell

H
H

Nero
Black

Grigio
Grey

60

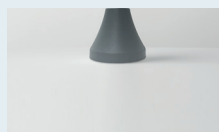

€ 10

Polipropilene Pp
Polypropylene Pp

60



STD

*Il piede **STD** è incluso nel prezzo del letto. In altezza ridotta disponibile senza sovrapprezzo.
STD feet included in bed price. Available in reduced height without extracharge.

► Sono disponibili
4 abbinamenti bicolore in ecopelle
There are 4 bi-color combinations in e-leather

(Vedi pag. 19 del catalogo
See page 19 of the catalogue)



Abb. 1
Silvia 24
Mover dk brown



Abb. 2
Silvia 05
Mover orchidea

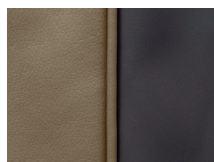

Abb. 3
Silvia 01
Mover rye

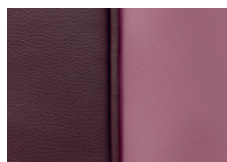
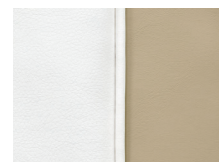
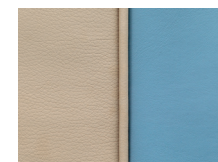

Abb. 4
Silvia 31
Mover fiordaliso